

[15] Island 5

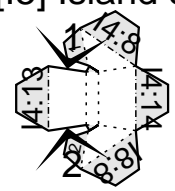

[16] Island 6

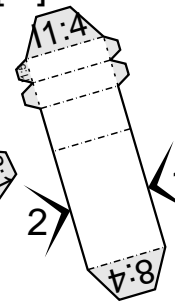

[17] Island

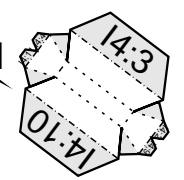

[13] Island 3

[14] Island 4

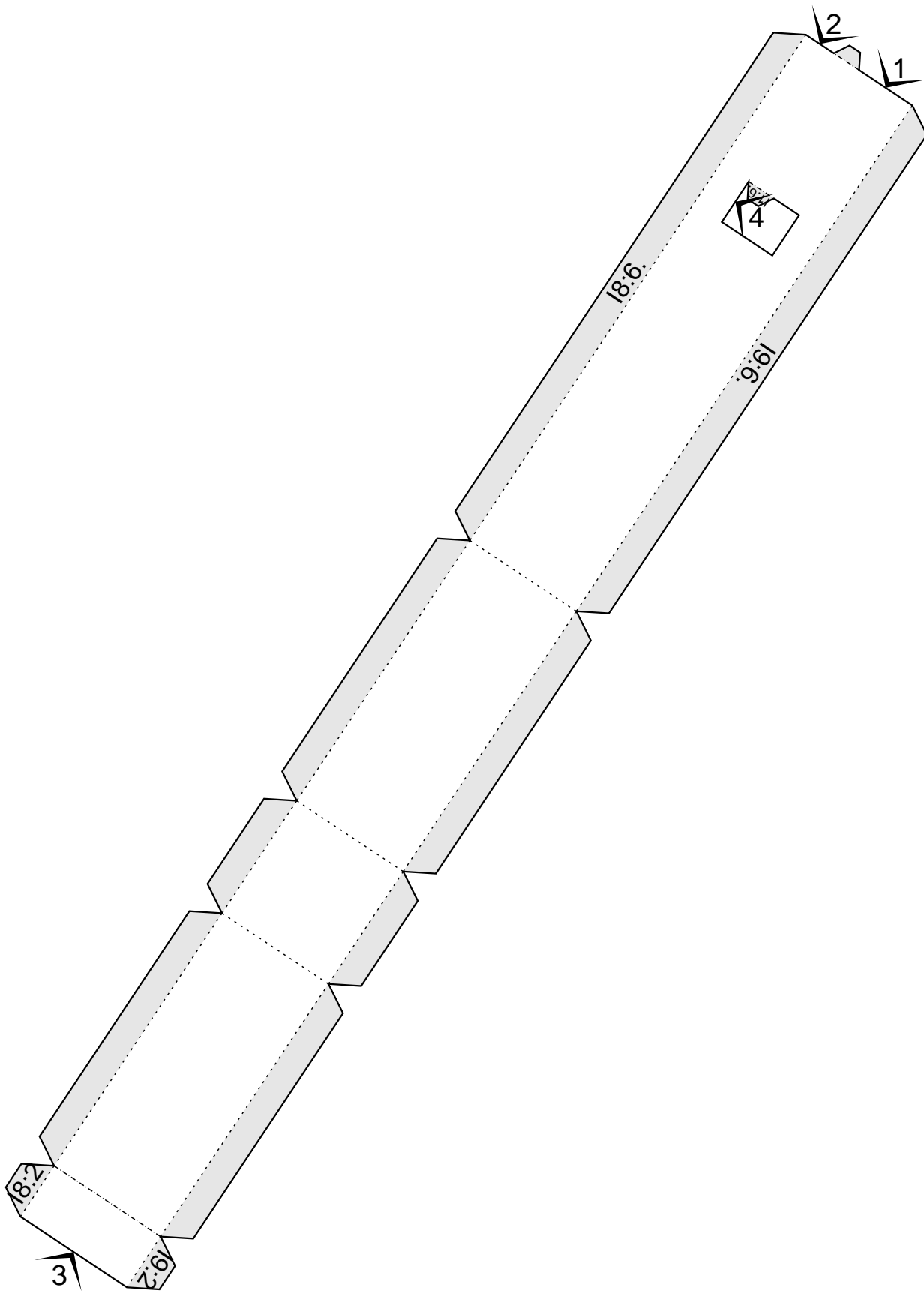

[12] Island 2

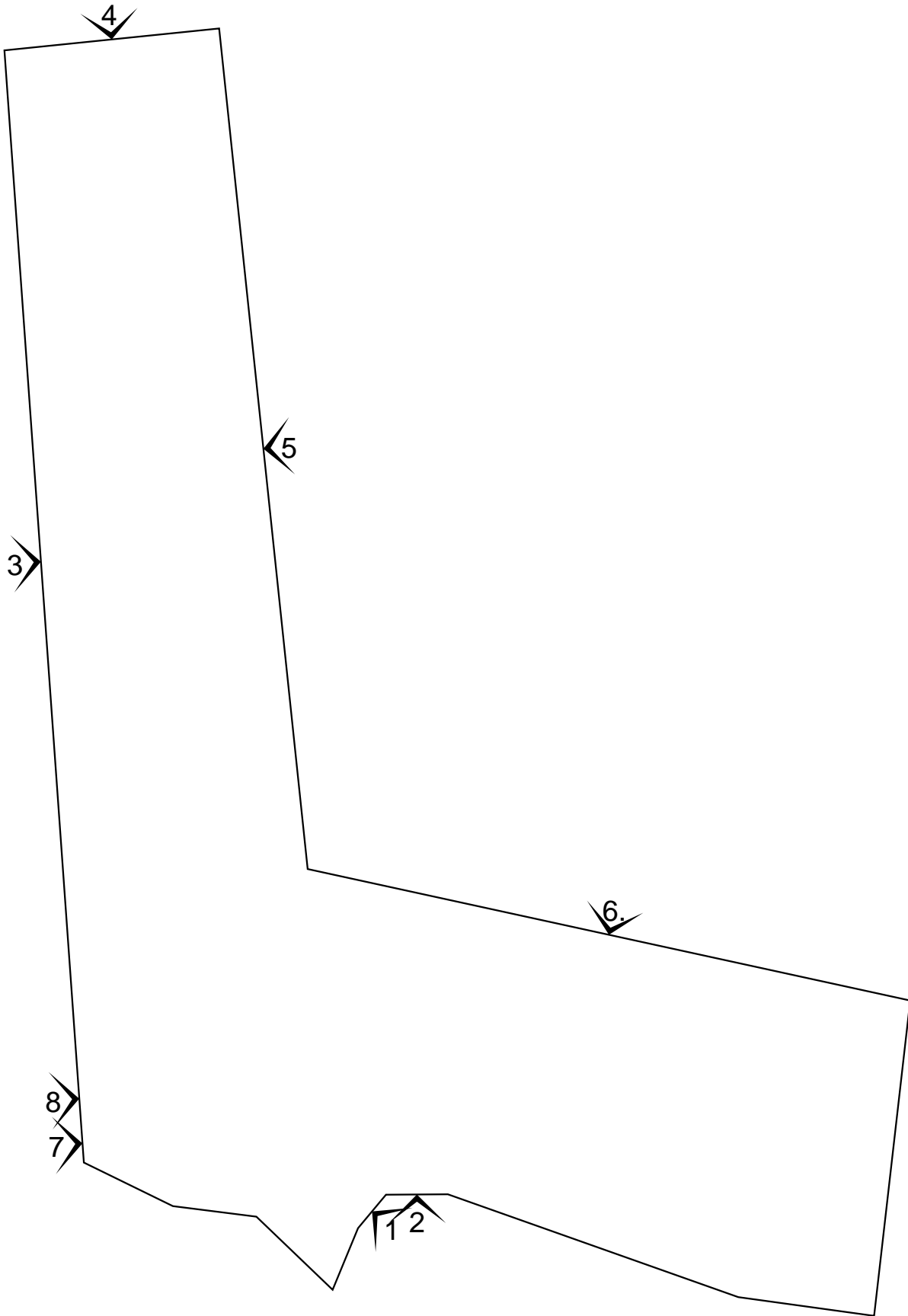

[18] Island 8

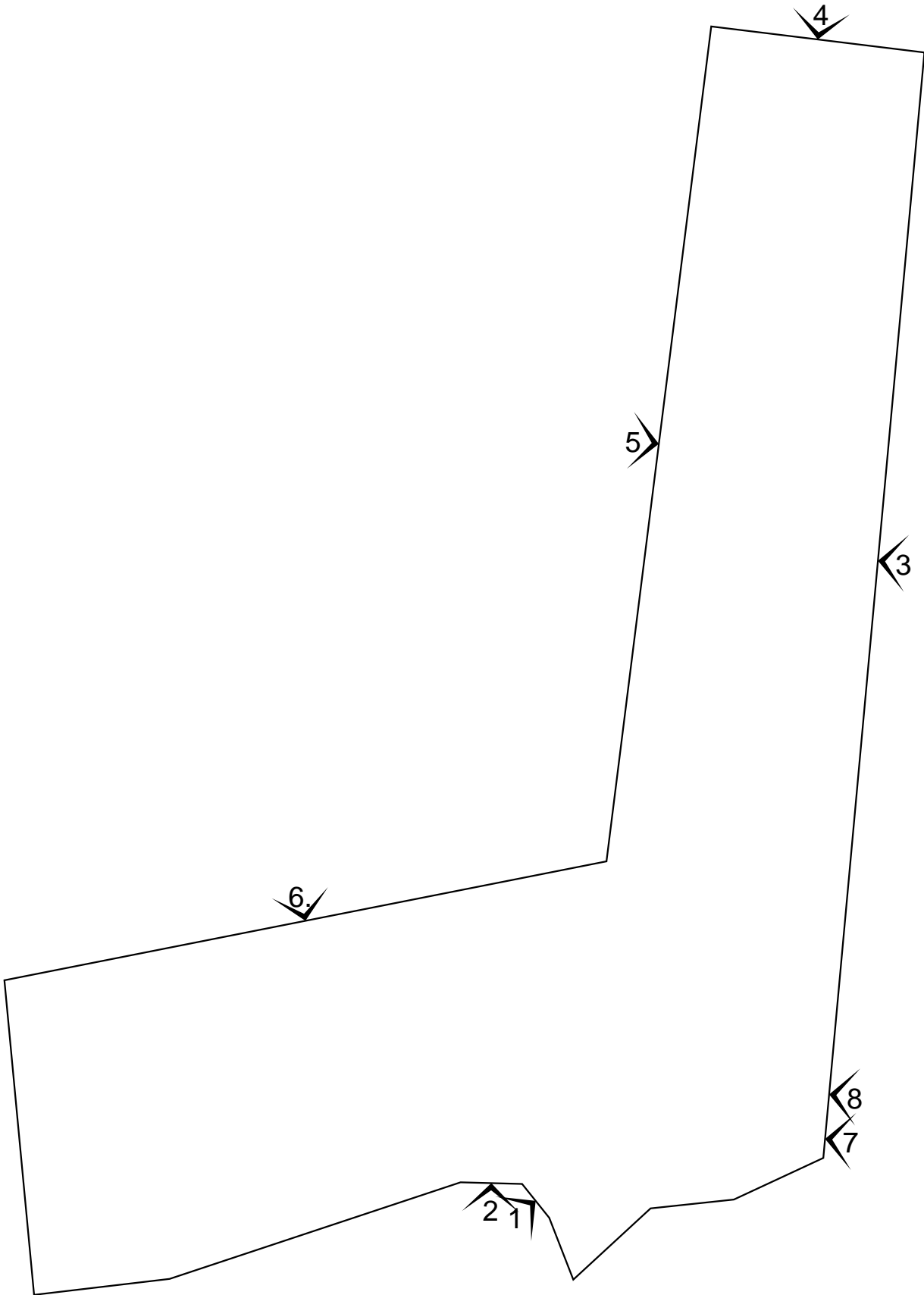

[I9] Island 9

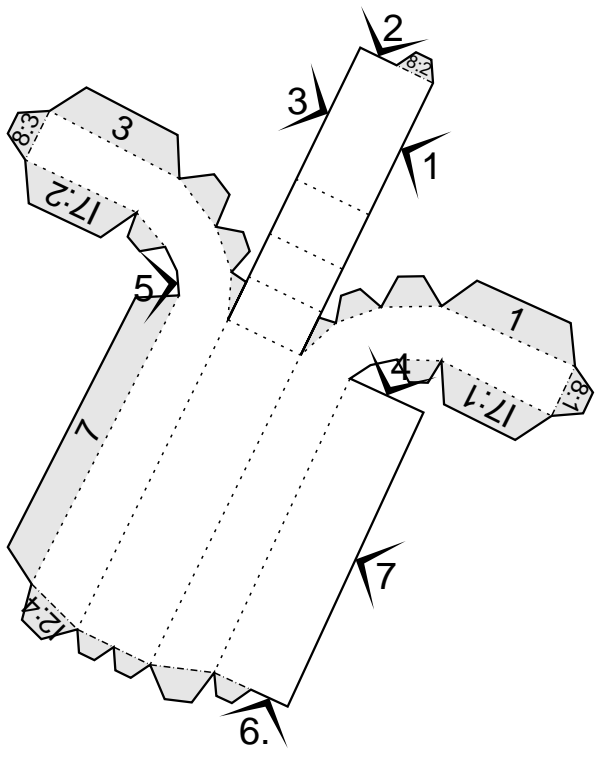

[I1] Island 1

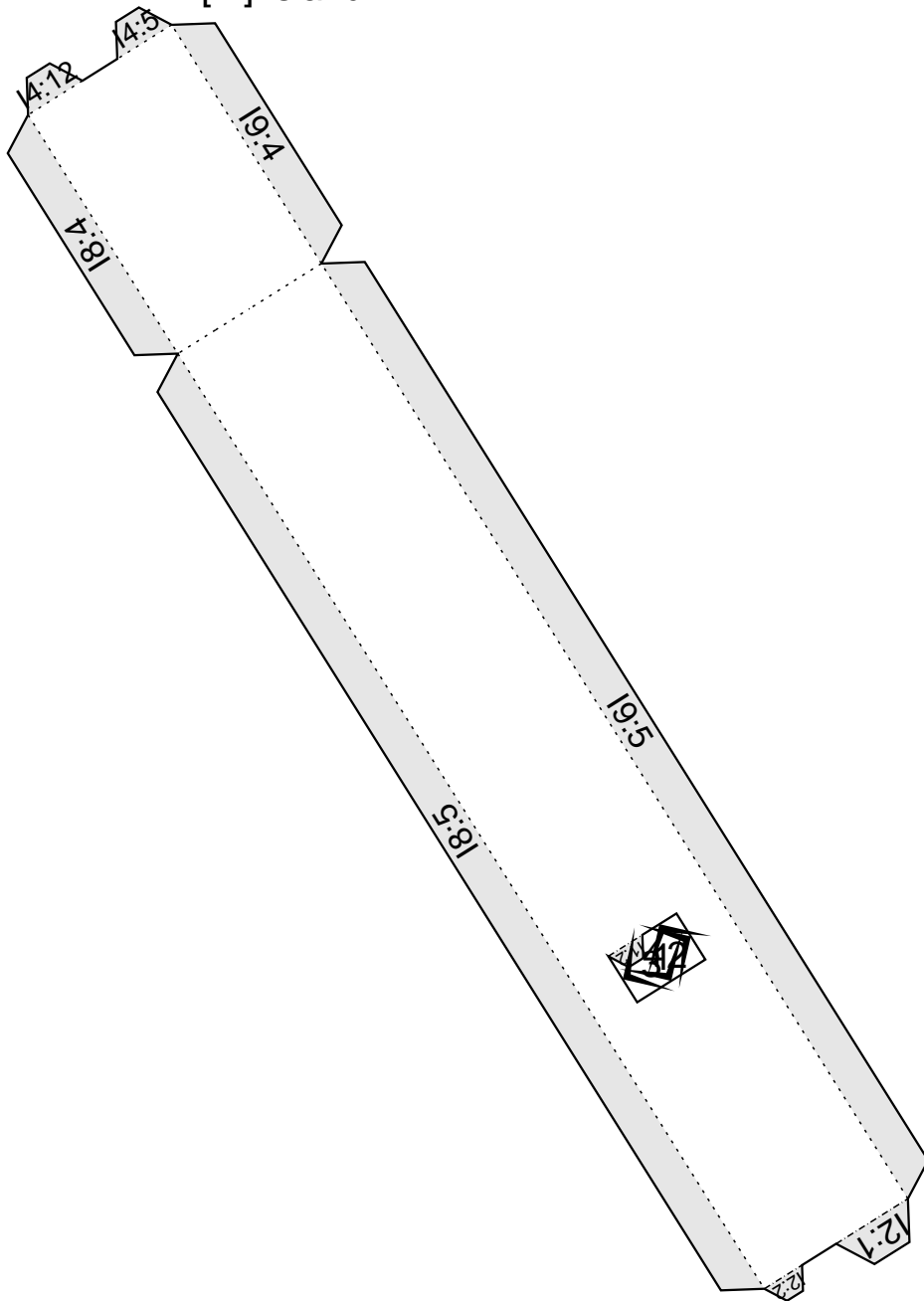

[8] Island 8